













# reformat™ Decorator

-  Direct Drive Servo Motors – reduces cost of ownership and maintenance
-  Improved efficiency – lower energy consumption
-  Servo registration – reduces time to produce an acceptable can
-  Intelligent drives – machine condition monitoring
-  Rear mounted Servo motors provide easy access for routine maintenance
-  Quick, safe and efficient access to all eight inkers – each inker is driven by its own independent motor
-  Variable speed Ductor roller allows for adjustments on the fly - fine adjustment of the Doctor blade means no tools required
-  Single mandrel trip with reliable operation at up to 2000cpm, can carriers designed for quick change
-  Independent pin chain drive motor
-  Positioning of Gravure roller contributes to reduced misting
-  OV unit is quick and easy to remove for maintenance, reducing hazards and providing a significant health & safety improvement
-  Carefully designed Inker guards and extract hoods improve operator access and health & safety

Contact our team to find out more about the reformat™ Decorator

Call Us +44(0)1274 846200  
 Email Us sales@cmbe.com  
 Online www.cmbe.com



## Technical Data

Width (machine alone):	2970mm
Height (machine alone):	3808mm
Length (machine alone):	5842mm
No. Mandrel spindle disc:	24
No. Independently driven inkers:	8
Mandrel trip:	Single
Weight:	40,500Kg
Cans per minute:	2000 (Subject to can size)
Can sizes:	202-211 diameter, 220mm
Can material:	Aluminium and Steel
Voltage:	400>480v
Supply:	3 Phase
Frequency:	50/60HZ
Full load current:	320A
Control Voltage AC:	110vac
Control Voltage DC:	24vdc
Vacuum requirements (max):	180scfm @ 22 in.Hg
Decorator Chain Pitch:	146.05mm (5-1/4")
Compressed clean air:	90 psi
Inker & OV exhaust requirements:	3500scfm @ 4in/Hg
Cooling water requirements:	Dedicated chiller sold with machine package
Varnish Pump:	Air operated Pump (inc and supplied with decorated system)

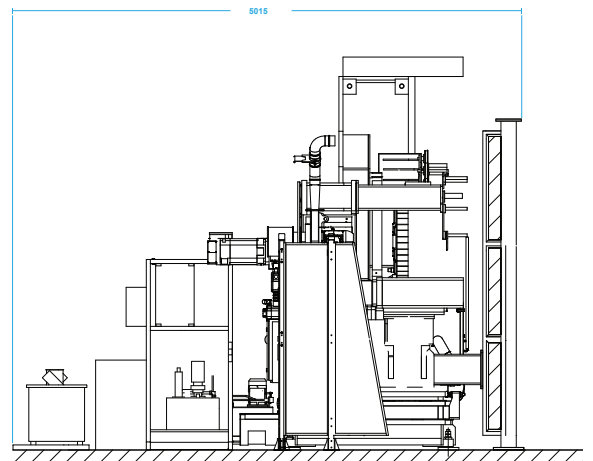
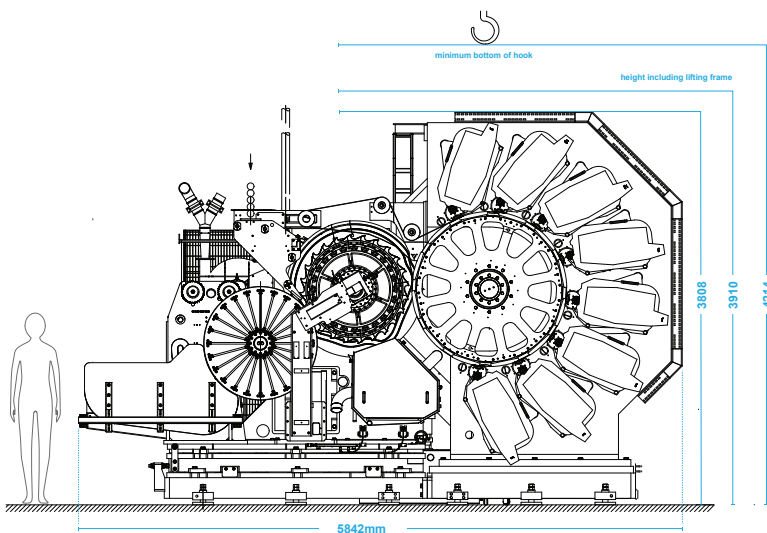

Contact our team to find out more about the reformat™ Decorator

Call Us +44(0)1274 846200  
 Email Us sales@cmbe.com  
 Online www.cmbe.com